



A MITEL
PRODUCT
GUIDE

MiContact Center Enterprise

Integrated Applications Script Manager User Guide

Release 9.7

Document Version 1.0

November 2023

Notices

The information contained in this document is believed to be accurate in all respects but is not warranted by **Mitel Networks™ Corporation (MITEL®)**.

The information is subject to change without notice and should not be construed in any way as a commitment by Mitel or any of its affiliates or subsidiaries. Mitel and its affiliates and subsidiaries assume no responsibility for any errors or omissions in this document. Revisions of this document or new editions of it may be issued to incorporate such changes. No part of this document can be reproduced or transmitted in any form or by any means - electronic or mechanical - for any purpose without written permission from Mitel Networks Corporation.

Trademarks

The trademarks, service marks, logos and graphics (collectively "Trademarks") appearing on Mitel's Internet sites or in its publications are registered and unregistered trademarks of Mitel Networks Corporation (MNC) or its subsidiaries (collectively "Mitel") or others. Use of the Trademarks is prohibited without the express consent from Mitel. Please contact our legal department at legal@mitel.com for additional information. For a list of the worldwide Mitel Networks Corporation registered trademarks, please refer to the website: <http://www.mitel.com/trademarks>.

®,™ Trademark of Mitel Networks Corporation

© Copyright 2023, Mitel Networks Corporation All rights reserved

INTRODUCTION.....	1
What You Will Learn.....	1
Before using the Tutorial.....	1
TUTORIALS	2
Using Script Manager to Logon Phone Agents	2
LogonScript.mfd.....	2
OnCallDelivered.....	2
MenuSelection	2
Assign	4
SendContactCenterData.....	4
Testing the Application	5
Send Fax	5
SendFax.mfd.....	6
Voice Prompts	8
Testing the Application	8
Send CDR	9
SendCDR.mfd.....	9
MenuSelection	9
Send Contact Center Data.....	9
Service Group	11
Voice Prompts	12
Testing the Application	13
Incoming SMS	14
IncomingSMS.mfd.....	15
OnSMS	15
JScriptExceute	16
Assign	16
SendSMS.....	17
Service Group	18
Testing the Application	19
Using Script Manager for queue handling	19
IVRQueue.mfd	19
OnCallDelivered.....	19
Get Contact Center Data	20
Condition	21
Service Group different queue.....	22
Service Group Requeue	22
Agent Available Event.....	22

Testing the Application 23

INTRODUCTION

This document contains sample scripts on how to use the Contact Center components and FAX components.

WHAT YOU WILL LEARN

In this document the following is discussed

- How to use the Fax component for Fax back requests.
- How to send additional CDR to the MiCC Enterprise database
- How to send additional CDR to agents
- How to receive and send SMS messages using the SMS components
- How to use Script Manager for Service Group queue handling
- How to use Script Manager to batch log on Phone Agents

BEFORE USING THE TUTORIAL

Make sure the sample scripts are installed on your development PC; see document Installing Sample Scripts.

Incoming SMS

Before running the script, make sure that the SMS Gateway is installed and at least one GSM modem or SMS-C is connected to the SMS Gateway Server. The SIM card is installed as stated in the document SMS Gateway.

Launch the SMS Gateway Configuration to configure the GSM modem or SMS-C. Check with your service provider for the modem number and the Service Center Address (SCA). Make sure the modem number, COM port and the SCA are correct before continue. The modem should be connected to the COM port as configured in the SMS Gateway configuration.

TUTORIALS

The tutorials include Using Script Manager to Logon Phone Agents, Send Fax, Send CDR, Incoming SMS and Using Script Manager for queue handling

USING SCRIPT MANAGER TO LOGON PHONE AGENTS

The LogonScript tutorial demonstrates how to use Script Manager to batch log on more than one Phone Agent. This allows the supervisor to log on, set ready and not ready status, and log off Phone Agents with a single call.

LOGONSCRIPT.MFD

From Script Designer, open the project called tutorials.fdp from the SampleScripts directory. Double clicking on the LogonScript.mfd script opens the script illustrated in Figure 1.

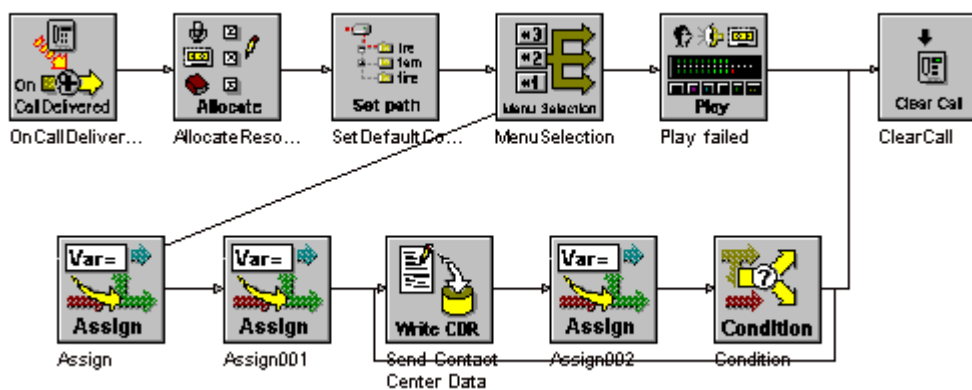

Figure 1: Logon Script



Note: The agent PIN and extension information must be defined in the MiCC Enterprise Configuration Manager before the script can successfully run. Replace the first Assign block with the information for the agent log on, either from a database or manually assigned.

ONCALLDELIVERED

The OnCallDelivered block receives an incoming call which triggers the logon script.

MENUSELECTION

The MenuSelection block plays a message defined on the messages text box; see Figure 2. The message prompts the user to enter '0' to set the agents to not ready, '1' to set the agents to ready and '#' to log off the agents. The entered digit will be stored in the @digit variable.

The screenshot shows a dialog box titled "MenuSelection Properties" with three tabs: "General", "Settings", and "Branches". The "Settings" tab is selected. The dialog is organized into several sections:

- Messages:** A group box containing three text input fields. The first field contains the text "2003".
- Key Detection Options:** A group box containing:
 - An unchecked checkbox labeled "Flush Pre-entered Keys".
 - A text input field labeled "Digits Received:" containing "@digit".
 - A text input field labeled "Global Key:" which is currently empty.
- Time-outs:** A group box containing:
 - A text input field labeled "Initial (ms):" containing "10000".
 - A text input field labeled "Inter-digit (ms):" containing "2000".
 - A text input field labeled "No. of Retries:" containing "0".
 - A text input field labeled "Retry Message:" which is currently empty.
- Invalid Digit:** A group box containing:
 - A text input field labeled "No. of Retries:" containing "0".
 - A text input field labeled "Message:" which is currently empty.

At the bottom of the dialog, there are four buttons: "OK", "Cancel", "Apply", and "Help".

Figure 2: Settings tab of MenuSelection Properties

If the user failed to enter a valid digit, the block will take the failure branch. The failure branch plays a message indicates an invalid option has been selected.

ASSIGN

In this example, the Assign block, see Figure 3, sets the data for each agent to be logged on. Each data field is a string variable containing: the pin that the agent uses for logon, the extension number to be used for the agent, the tenant ID, and the OAS server ID. The tenant ID and the OAS server ID are available from the MiCC Enterprise database. For non-tenanted configuration, the tenant ID is -1.

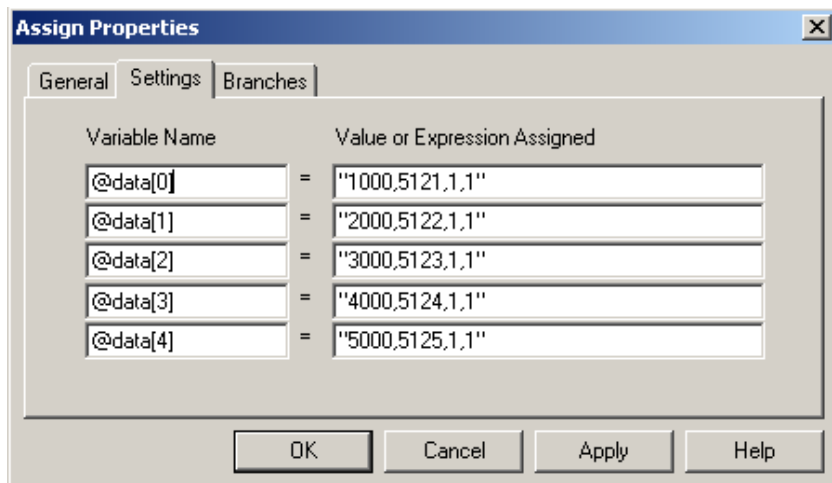

Figure 3: Settings tab if the Assign Properties Dialogue box

SENDCONTACTCENTERDATA

The SendContactCenterData block sends each agent logon information to the

MiCC Enterprise Router Service including the following keywords to indicate this is a Phone Agent logon. This will automatically change the agent status based on the data provided. This block must containing only two descriptions and data fields; see Figure 4 for a screen shot and Table 1 for an explanation of the Description and Data Fields.

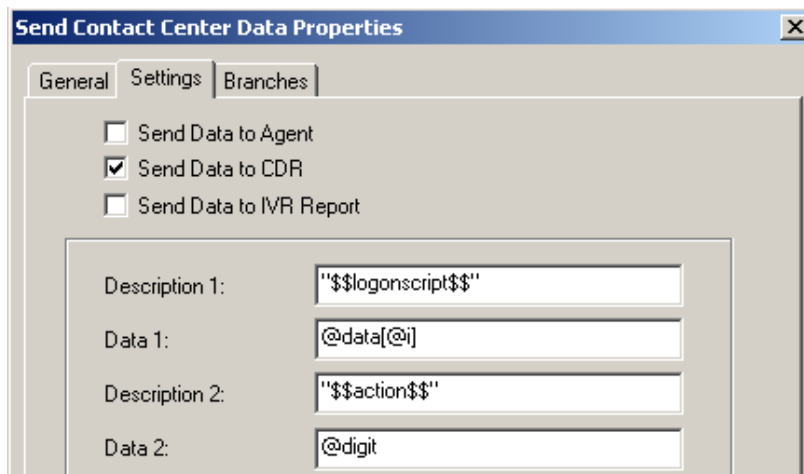

Figure 4: Settings tab of Send Contact Center Data Properties

Table 1: Allowed values in Description and Data fields

DESCRIPTION1	“\$\$LOGONSCRIPT\$\$” CASE-SENSITIVE
Data1	A string constant or variable contains <pin>, <extensions>, <tenant ID>, <OAS Server ID>
DESCRIPTION2	“\$\$ACTION\$\$” CASE-SENSITIVE
Data2	A string constant or variable with exactly one character. '1' Set agent to ready state. The system will logon the agent if not already logged on. '0' Set agent to not ready state. The system will logon the agent if not already logged on. '#' Log off the agent

The script runs through each element in the @data array to set the agent to the new status. Verify the status of the agents via Information Manager.

TESTING THE APPLICATION

Enter the correct parameters in each component and compile the script, then create a Script Manager Service Access. Make sure Script Manager is running in the MiCC Enterprise integrated environment and the Service Access is created using Configuration Manager. Activate the Service Access. Make a call to the Service Access and follow the prompts to set the agent to ready, not ready and log off. Verify the agent status from Information Manager. Once the agent is in ready status, the Phone Agent will be ready to receive service calls as if logged on manually via the logon script.

SEND FAX

This tutorial provides simple fax back functionality with integration to the OneBox FAX feature. A user account must be available for Script Manager to access the OneBox FAX Server. The user calls to the system and enters the fax number to be called. Then the user selects a specific document to be faxed back. The system makes a request to the OneBox FAX Server to fax the requested document. The system plays a confirmation message if the fax request was successful. It will play a failure message if the request failed.

SENDER.MFD

From Script Designer, open the project called tutorials.fdp from the SampleScripts directory. Double clicking on the FaxBack.mfd script opens the script illustrated in Figure 5.

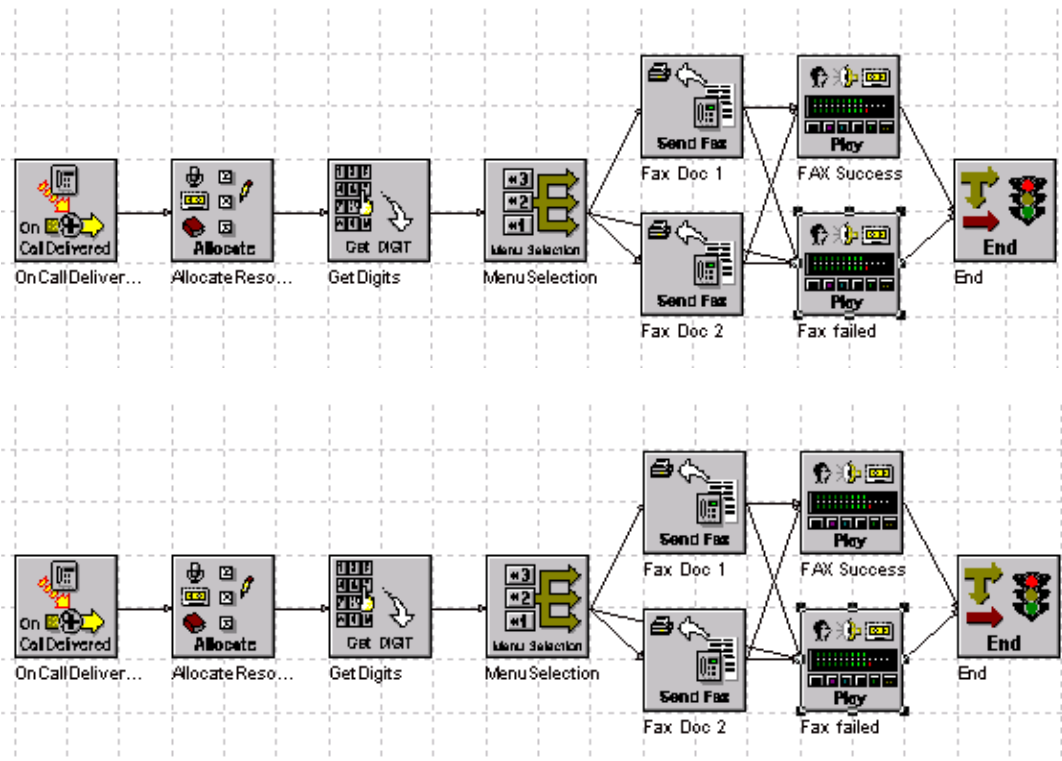

Figure 5: Fax Back Script

Send Fax component

The SendFax component uses the OneBox FAX server to send the outgoing fax; see Figure 6 for the Settings tab of the Send Fax Properties.

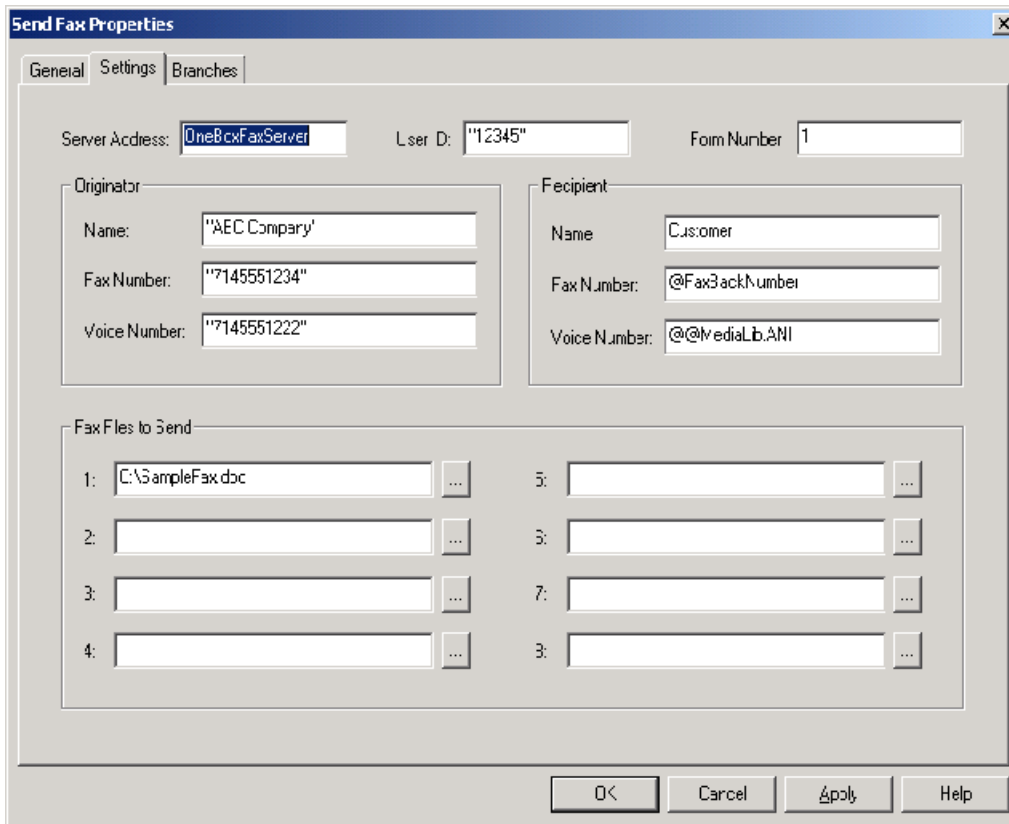

Figure 6: Settings tab of Send Fax Properties dialogue box

Server Address

Enter your OneBox FAX server name or the IP address.

User ID

This is the user ID that will be used to send the outgoing fax. Make sure this is a valid user ID to access the OneBox FAX server.

Form number

The fax form overlay to be used to send the fax. This must be configured in your OneBox FAX Server.

Originator Name, Fax number and Voice number

Enter the name of the originator. This usually is the company name. The fax number and the voice number are optional. This information will be printed on the fax and can be used for the fax recipient to contact the originator.

Recipient Name, Fax number and Voice number

The name of the recipient and the voice number are printed on the fax. These are used as a reference. The recipient fax number is the most important information for the fax to be sent to the correct destination.

Fax Files

You can fax up to eight files at a time. The type of files must be supported by your fax server. Check your OneBox FAX server for the supported file types.

VOICE PROMPTS

The voice prompts in Table 2 need to be recorded and configured as play messages in the OAS Server. The default message IDs are provided in the following table. If a different message ID is used in the OAS Server, re-configure the variables with the new message ID when creating the Service Access.

Table 2: Voice Prompts

SCRIPT MANAGER VARIABLE	MESSAGE ID	SAMPLE VOICE PROMPT DESCRIPTION
MsgFaxFailed	1160	"Your fax request has failed, please try again later."
MsgFaxOK	1161	"Your fax request is accepted. You will be receiving your document in a short time. "
MsgGetPhone	1162	"Please enter your fax number."
MsgRetry	1163	"You have entered an invalid option."
MsgRetryPhone	1164	"Please re-enter your fax number."
MsgSelection	1165	"For product information, press 0, For Support information, press 1"

TESTING THE APPLICATION

After updating the Sendfax component, compile and create a Service Access using the FaxBack script. Use the Variable button to configure the variables for the MonitorDev and play messages. Make sure your Script Manager Server has access to your OneBox FAX server. Test your Script.

SEND CDR

The SendCDR tutorial demonstrates collecting CDR data and storing it in the MiCC Enterprise database. This allows the user to monitor certain information that occurs in the script, such as a user’s selection history. The script also provides additional data to MiContact Center Agent, which is displayed in the Call Window and provided in the DDE and COM interfaces for third party applications.

SENDCCR.MFD

From Script Designer, open the project called tutorials.fdp from the SampleScripts directory. Double click on the SendCDR.mfd script to open the script shown in Figure 7.

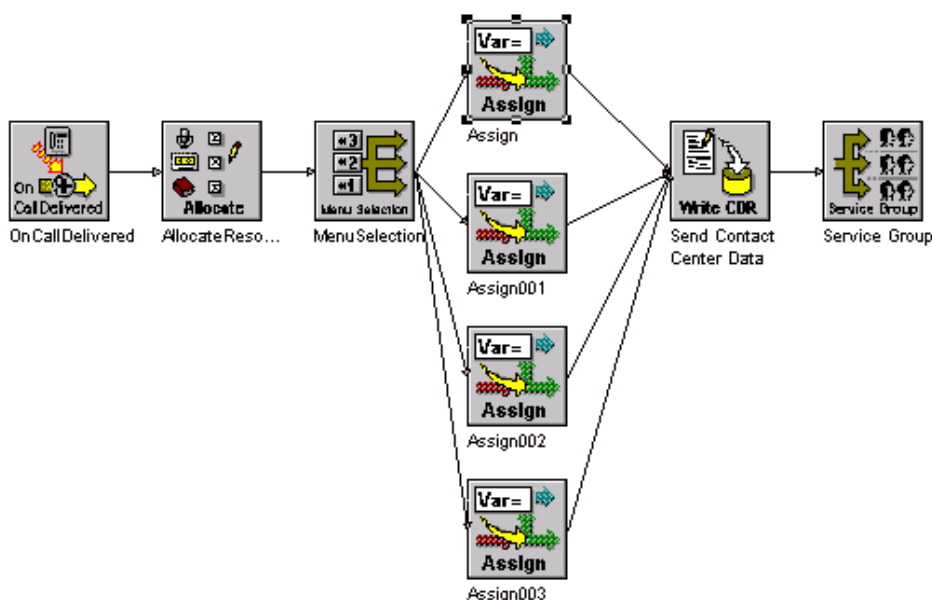

Figure 7: Send CDR script

MENUSELECTION

The MenuSelection block in the script prompts the user for the type of services needed. For each of the selections, the type of service is saved into the string variable @szService in the next Assign block. This will be useful information to be stored in the database and/or presented to the agent.

SEND CONTACT CENTER DATA

The Send Contact Center Data block must be placed before the ServiceGroup block for the data to be forwarded to Desktop Manager or the database. If the block is placed after queuing to the Service Group, the block will fail.

See Figure 8 for a screen shot of the Settings tab of the Send Contact Center Data Properties dialogue box.

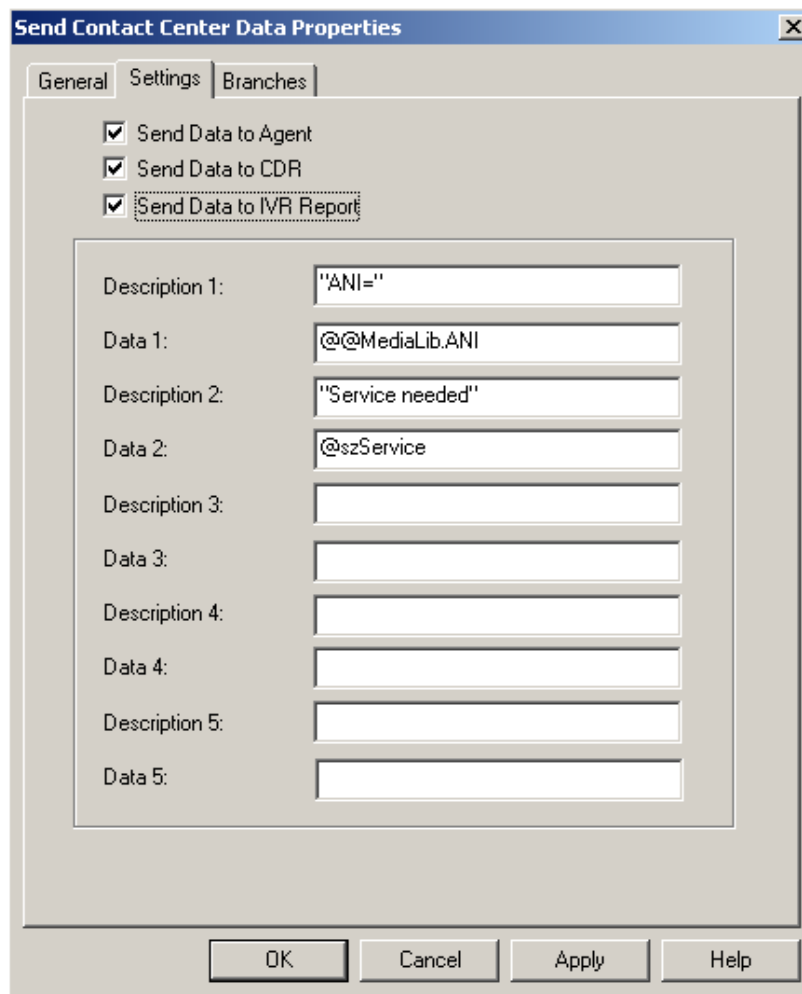

Figure 8: Settings tab of the Send Contact Center Data Properties dialogue box

Send Data to Agent

The Send Data to Agent option controls whether the data will be sent to Desktop Manager.

Send Data to CDR

The Send Data to CDR option indicates the data provided below will be sent to the Contact Center database to be stored as CDR data for the call.

Send Data to IVR Report

The Send Data to IVR Report option indicates the data provided below will be sent to the Contact Center database to be stored for reporting through Report Manager.

The user can select one or more options. This means the same data will display in the MiContact Center Agent Call Window and be stored in the database. When requesting to store in the database as CDR data, make sure the Log Call Detail

Data option is enabled in the MiCC Enterprise Configuration Manager.

Description and Data (1-5)

The description field is a description of the data provided in the data field. You can have up to 5 sets of data per SendContactCenterData block. If more data needs to be provided, additional SendContactCenterData blocks can be used. It can be used anywhere in the script as long as it is executed before the call is sent to the Service Group. A maximum of 10 fields will be displayed in MiContact Center Agent.

SERVICE GROUP

The ServiceGroup block queues the call to a Service Group in the Contact Center; see Figure 9.

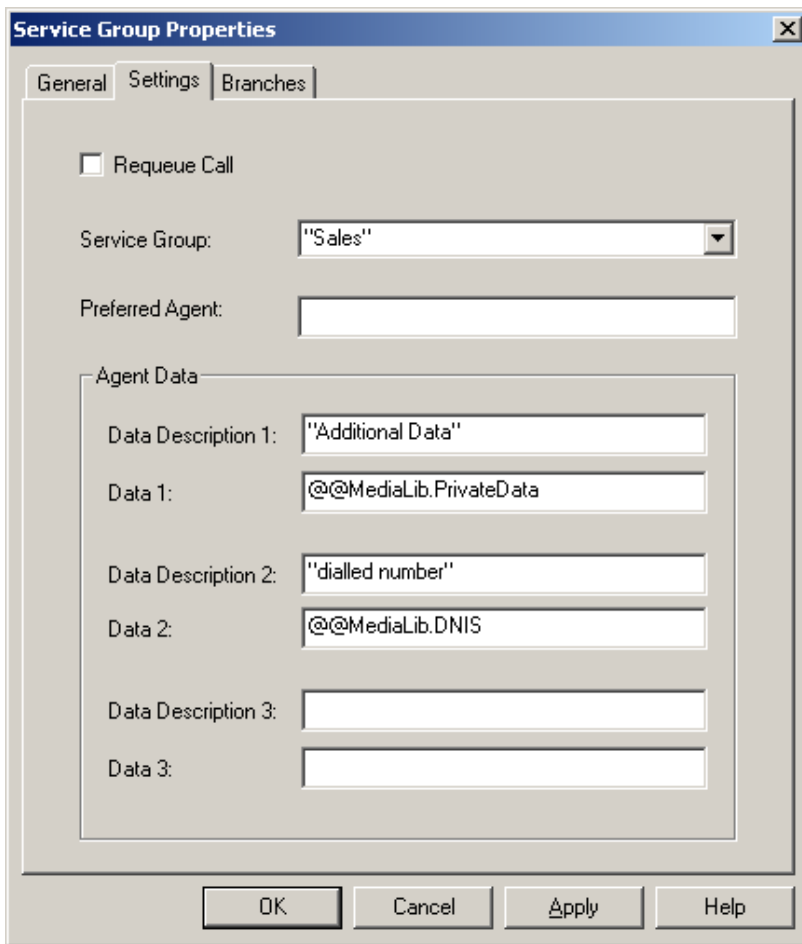

Figure 9: Settings tab of Service Group Properties

Requeue Call

If the call is diverted from a Service Group queue for repeat queue handling, the user can enable this option to put the call back into the original queue. The Service Group name field can be blank.

If this is a new incoming call, do not enable this option. A Service Group name must be provided.

Service Group

The name of the service group must be provided. The names are case-sensitive and must match exactly to the name defined in Configuration Manager. If the MiCC Enterprise Server is connected during the script design, the available Service Group names will be provided in the drop-down list. The user can select one of the service groups to be used. If the Script Designer has no connection to the MiCC Enterprise Server, an archived copy of the Service Group may be available. The user can also manually enter the name of the Service Group or a string variable containing the name of the Service Group.

Preferred Agent

The user can choose to select a preferred agent to handle this call. An internal record id of the agent can be placed in the Preferred Agent field. The Service Group properties defined in Configuration Manager must enable the preferred agent routing and the agent must be able to serve for that Service Group in order to route the call to the preferred agent.

Agent Data Description and Data (1-3)

The ServiceGroup block allows three set of agent data to be sent to MiContact Center Agent when the call is sent to the agent. The data in this block only goes to MiContact Center Agent. It is not stored in the database as CDR data. The user must use the SendContactCenterData block to send additional data to the CDR database.

In this example, the agent data are system variables provided in the media component library. They can also be static data, menu selection digits or any database information. This information can be used by the agent to provide better service to the customer.

VOICE PROMPTS

The following voice prompts (see Table 3) need to be recorded and configured as play messages in the OAS Server. The default message IDs are provided in the following table. If a different message ID is used in the OAS Server, re-configure the variables with the new message ID when creating the Service Access.

Table 3: Voice Prompts

SCRIPT MANAGER VARIABLE	MESSAGE ID	SAMPLE VOICE PROMPT DESCRIPTION
MsgSelection	1170	"For Internet Service, press 0, For Cable Service, press 1, for Billing, press2."

TESTING THE APPLICATION

Enter the correct parameters in each component and compile the script, then create a Service Access. Make sure Script Manager is running in the MiCC Enterprise integrated environment and the Service Access is created using Configuration Manager. These two components are not available for a Script Manager stand-alone installation.

MiContact Center Agent Sessions Window

The MiContact Center Agent Sessions Window (see Figure 10) displays the agent data provided from the Send Contact Center Data and the Service Group block.

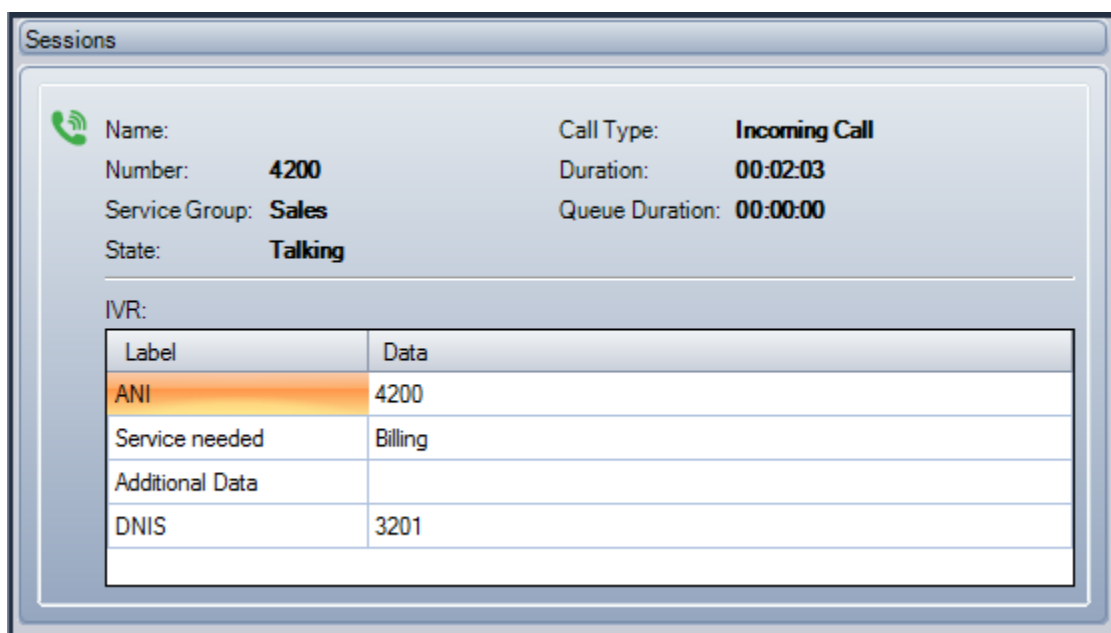

Figure 10: MiContact Center Agent Sessions Window

Call Detail Data

Generate the Call Records from Report Manager. The data provided in the SendContactCenterData is stored as CDR data and shown in Call Detail Data window as seen in Figure 11.

Caller Number	Time Stamp	Call Event	Name
4200	9/03/2015 14:26:13	Call entered Service Access	Sales
	9/03/2015 14:26:17	IVR data - ANI 4200	
	9/03/2015 14:26:17	IVR data - Service needed Billing	
	9/03/2015 14:26:18	Call entered Service Group queue	Sales
	9/03/2015 14:26:18	Call routed to agent - 1st choice agent selected	Smith, John
	9/03/2015 14:26:18	Call alerting	Smith, John
	9/03/2015 14:26:20	Call answered	
	9/03/2015 14:26:29	Call completed - Disconnected by Agent	

Figure 11: Call Detail Data Window

INCOMING SMS

The IncomingSMS tutorial demonstrates how to receive an incoming SMS message and send a reply. Alternatively, the script can queue the incoming SMS message to a SMS service group. The same routing rule will be used to select the most suitable agent to handle the SMS message.

INCOMINGSMS.MFD

From Script Designer, open the project called tutorials.fdp from the SampleScripts directory. Double click on the IncomingSMS.mfd script to open the script in Figure 12.

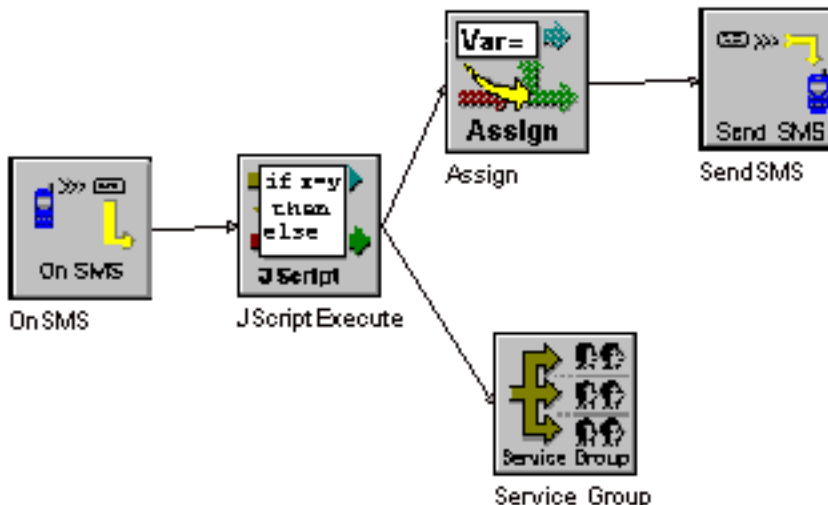

Figure 12: Incoming SMS

ONSMS

The OnSMS block (see Figure 13) in the script waits for an incoming SMS messages on the SMS address.

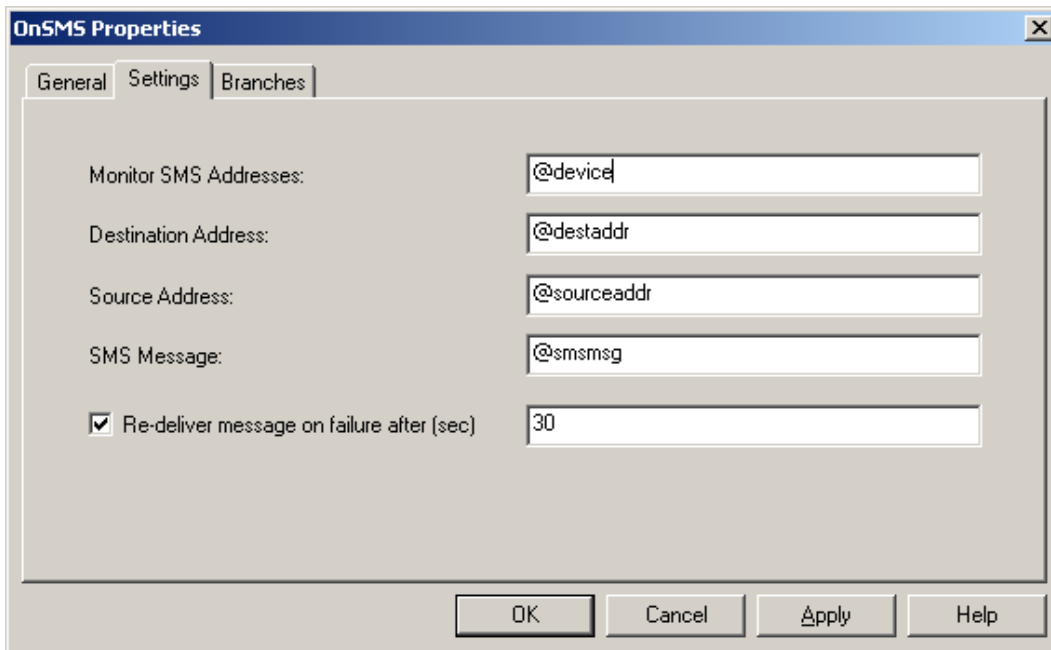

Figure 13: Settings tab of OnSMS properties

The @device is a string variable containing the SMS address (the modem address configured in the SMS Gateway Configuration). @destaddr and @sourceaddr will contain the calling number and the called number of the received SMS message. The @smsmsg contains the actual SMS message.

JSCRIPTEXCEUTE

The JScriptExecute (see Figure 14) gets the SMS message content and looks for the text “interest”, which represent “interest rate”. If the text is in the SMS message, then it will branch to the Assign block to set the interest rate information.

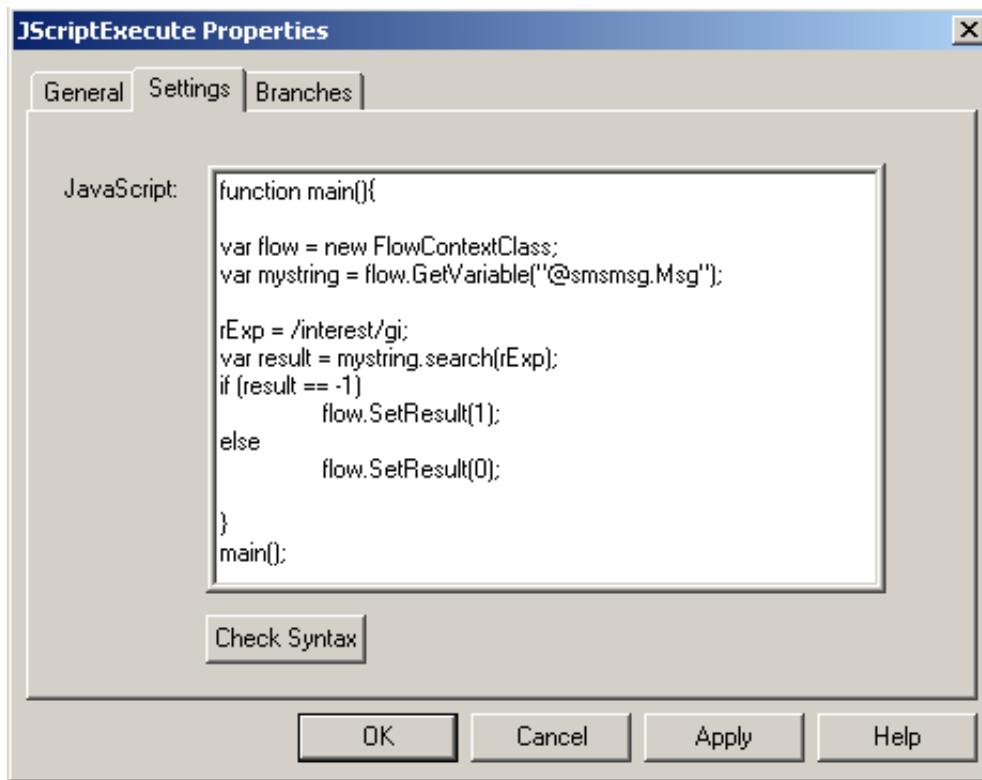

Figure 14: Settings tab of JScriptExecute

ASSIGN

The Assign block (see Figure 15) sets the message content by assigning the current interest rate information as a text string to the @smsmsg.Msg variable. The length of the SMS message also needs to be set to @smsmsg.MsgLen. This will be the reply message to the caller.

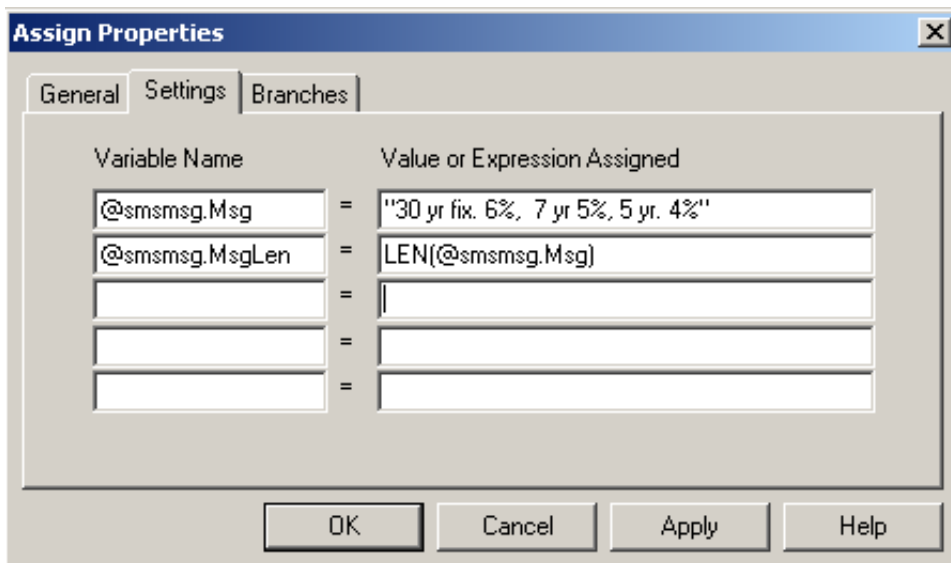

Figure 15: Settings tab of Assign Properties

SENDSMS

The SendSMS block (see Figure 16) sends a reply to the incoming message. The content of the SMS message has already been set in the Assign block. The “reply to an incoming SMS message” is set in this case to remove the incoming SMS message from the database once this message has been replied to. The same SMS message will not be able to send another reply or queue to the Service Group.

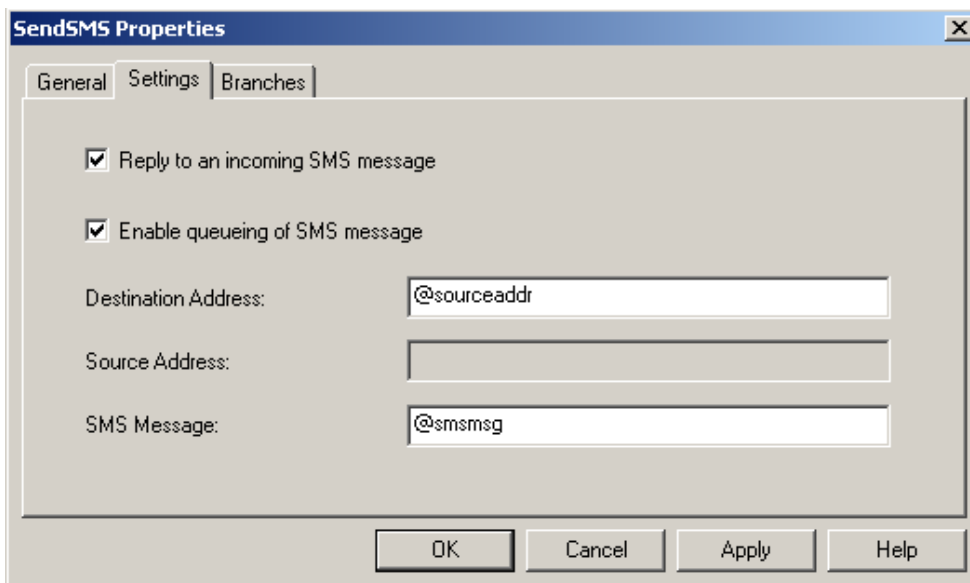

Figure 16: Settings tab of Send SMS Properties

SERVICE GROUP

If the incoming SMS message does not contain the text “interest”, the SMS message will be queued to the Service Group to be handled by a live agent (see Figure 17). The Service Group field must provide a valid SMS Service Group. Make sure the SMS message has not been replied to before queuing to the Service Group. Otherwise the Service Group block will result in failure.

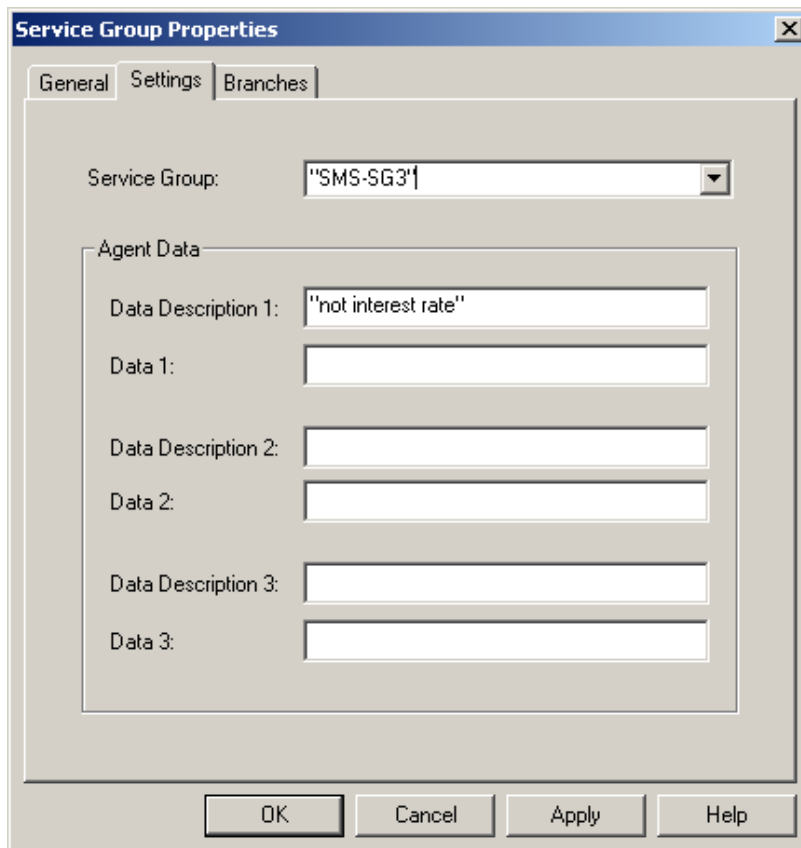

Figure 17: Settings tab of Service Group Properties

The names are case-sensitive and must match exactly to the name defined in

Configuration Manager. If the MiCC Enterprise Server is connected during the script design, the available Service Group names will be provided in the drop-down list. The user can select one of the SMS service groups to be used. If the Script Designer has no connection to the MiCC Enterprise Server, an archived copy of the Service Group may be available. The user can also manually enter the name of the Service Group or a string variable containing the name of the Service Group.

TESTING THE APPLICATION

1. Enter the correct parameters in each component.
2. Compile the script and create a Service Access.
3. Make sure the Script Manager is running in the MiCC Enterprise integrated environment and the Service Access is created using Configuration Manager.

Configure the @device variable from Configuration Manager – Service Access – Variable.

4. Make sure the modem number is configured via the SMS Gateway Configuration.
5. Send an SMS message to the modem number containing the text “interest rate”. A successful result is to receive the interest rate quote on the originator’s number. If there is a problem receiving the SMS message, make sure the Service Center Address is configured properly.

USING SCRIPT MANAGER FOR QUEUE HANDLING

The IVRQueue tutorial demonstrates how to use Script Manager for Service Group queue handling. This allows the user to provide advanced queue handling while waiting in the Service Group queue and still maintaining the queue position.

IVRQUEUE.MFD

From Script Designer, open the project called tutorials.fdp from the SampleScripts directory. Double click on the IVRQueue.mfd script to open the script in Figure 18.

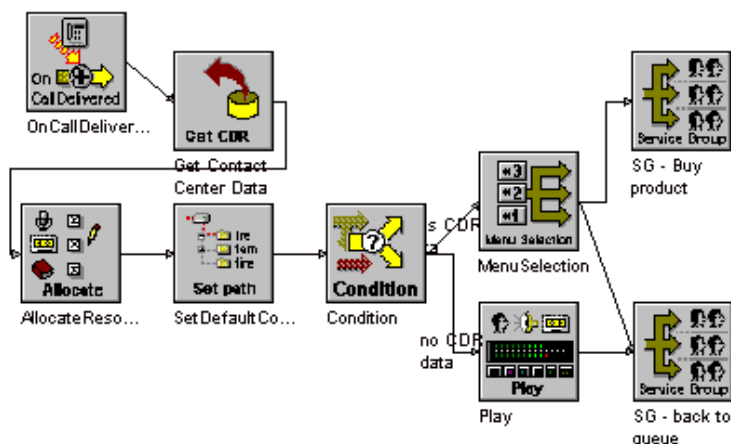

Figure 18: IVR Queue

ONCALLDELIVERED

The OnCallDelivered block receives the call from the Service Group queue and starts processing based on the script.

GET CONTACT CENTER DATA

The Get Contact Center Data block (see Figure 19) obtains the call detail data collected during the pre-termination routing of the call.

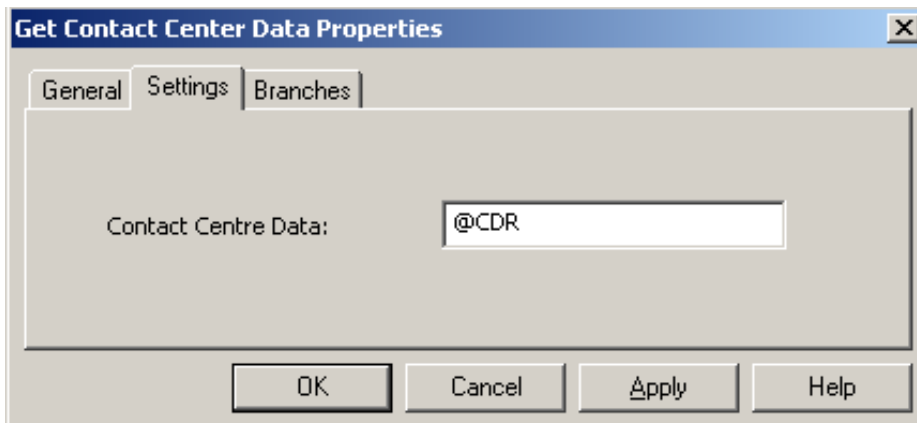

Figure 19: Settings tab of Get Contact Center Data properties

The @CDR is a variable of the CCData object type (see Figure 20).

Name	Type	Derived From	Dimension	Global	Configur...
CDR	Object	CCLib.CCData	Zero	False	False

Session Variables Script Variables System Variables E ◀ ▶

Figure 20: @CDR variable

The user can examine the call detail data that was previously obtained (see Figure 21) to determine which path of the script to take. To access the data:

@CDR.TotalCCData number of call detail data available

@CDR.CCDataList[0].Description the description of the 1st element of call detail data

@CDR.CCDataList[0].Data the data of the 1st element of the call detail data

Object Name	Type	Library	Comments
CCData	System	CCLib	Call Center Data Object
CCDataItem	System	CCLib	Call Center Data Item
NLRecognitionResult	System	MediaLib	Natural Language Recognition Result Object
RecognitionResult	System	MediaLib	Recognition Result Object
SlotInfo	System	MediaLib	Natural Language Recognition Slot Information
SMSAddr	System	SMSLib	SMS Address Object
SMSMsg	System	SMSLib	SMS Message Object

Event Handlers | User Exceptions | User Events | Objects

Figure 21: Call Detail Data

CONDITION

The Condition block (see Figure 22) checks for any existing call detail data. It will take on a different path if there is existing data.

Condition Properties

General | Settings | Branches

Operator

L1
 If @CDR.TotalCCData EQ 0
 Then [] Else []

L2
 If [] [] []
 Then [] Else []

L3
 If [] [] []
 Then [] Else []

L4
 If [] [] []
 Then [] Else []

L5
 If [] [] []
 Then [] Else []

OK Cancel Apply Help

Figure 22: Settings tab of Condition block

SERVICE GROUP DIFFERENT QUEUE

The Service Group block (see Figure 23) returns the call to the Service Group queue. In case the customer chooses to leave the current queue, the Service Group block sends the call to a different Service Group which handles such selection, for example to purchase the advertised product. The call is then removed from the original queue and placed in a different queue. The Requeue Call option indicates whether the call will be returned to the original queue.

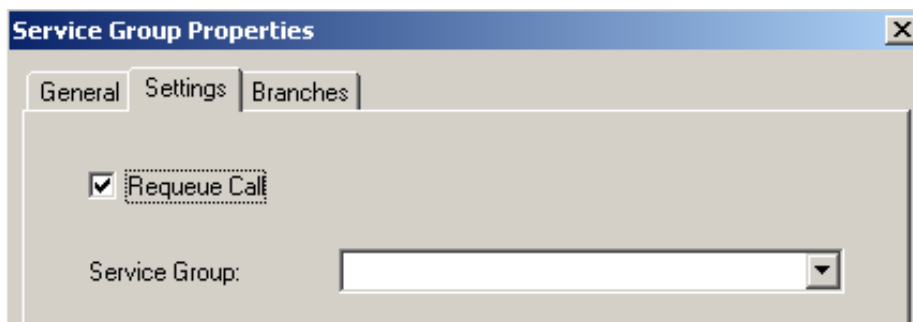

Figure 23: Service Group block

SERVICE GROUP REQUEUE

If the customer chooses to remain in the Service Group queue, by checking the Requeue Call check box, the call will be placed back in the queue maintaining the original queue position.

AGENT AVAILABLE EVENT

The Agent Available Event handler (see Figure 24) defines whether the script will take a different path when the system is notified that an agent is available. If there is no handler defined for the Agent Available Event, the call continues based on the script. If a handler is defined, the path of execution will continue on the Event Handler Block. This could be playing a message indicating an agent is ready to answer your call, and then immediately sending the call back to the Service Group queue and allowing the call to be routed to the agent.

Event Name	Library Name	Event Handling Block
Agent Available Event	CCLib	SG - back to original queue
Block Not Connected	SystemLib	
Call Disconnected Event	MediaLib	
Call Diverted Event	MediaLib	
System Error	SystemLib	

Figure 24: Agent Available event

TESTING THE APPLICATION

1. Enter the correct parameters in each component and compile the script and create a Script Manager Service Access.
2. Make sure Script Manager is running in the MiCC Enterprise integrated environment and the Service Access is created using Configuration Manager.



Note: The Contact Center components are not available for a Script Manager stand alone installation.

3. Create a Service Group with voice purpose.
4. Configure the Service Group queue to use IVR queue handling.
5. Select the Script Manager Service Access as the queue handler.
6. Make a call and let the call wait in queue.
7. Listen to the different options provided in the script.
8. Make an agent available and the call will be routed to the agent.



[mitel.com](https://www.mitel.com)

© Copyright 2020, Mitel Networks Corporation. All Rights Reserved. The Mitel word and logo are trademarks of Mitel Networks Corporation, including itself and subsidiaries and authorized entities. Any reference to third party trademarks are for reference only and Mitel makes no representation of ownership of these marks.