

Mitel MiContact Center Enterprise

VIRTUAL CONTACT CENTER CONFIGURATION - DESCRIPTION

RELEASE 9.5 SP2



NOTICE

The information contained in this document is believed to be accurate in all respects but is not warranted by Mitel Networks™ Corporation (MITEL®). The information is subject to change without notice and should not be construed in any way as a commitment by Mitel or any of its affiliates or subsidiaries. Mitel and its affiliates and subsidiaries assume no responsibility for any errors or omissions in this document. Revisions of this document or new editions of it may be issued to incorporate such changes.

No part of this document can be reproduced or transmitted in any form or by any means - electronic or mechanical - for any purpose without written permission from Mitel Networks Corporation.

TRADEMARKS

The trademarks, service marks, logos and graphics (collectively "Trademarks") appearing on Mitel's Internet sites or in its publications are registered and unregistered trademarks of Mitel Networks Corporation (MNC) or its subsidiaries (collectively "Mitel") or others. Use of the Trademarks is prohibited without the express consent from Mitel. Please contact our legal department at legal@mitel.com for additional information. For a list of the worldwide Mitel Networks Corporation registered trademarks, please refer to the website: <http://www.mitel.com/trademarks>.

Virtual Contact Center Configuration, Description
Release 9.5 SP2 - October 2021

®,™ Trademark of Mitel Networks Corporation ©
Copyright 2021 Mitel Networks Corporation All
rights reserved

INTRODUCTION

This document consists of an overview of the MiCC Enterprise system in different network configurations and descriptions of how they are configured.

OVERVIEW

MiCC Enterprise can be configured to support virtual contact centers at multiple sites and each site can be configured to use more than one Open Application Server (OAS).

 Note: In this release, it is not possible to include TAS based nodes in a VCC. Only OAS/MX-ONE nodes are supported in a VCC network.

MULTIPLE SITES

Up to 20 sites (MX-ONE nodes) can be configured in MiCC Enterprise with virtual contact center support. Each site is a MX-ONE Telephony System (TSW or TSE) with at least one OAS server. MiCC Enterprise can use up to 20 OAS servers, which means that a total number of 20 Virtual Contact Centers can be configured.

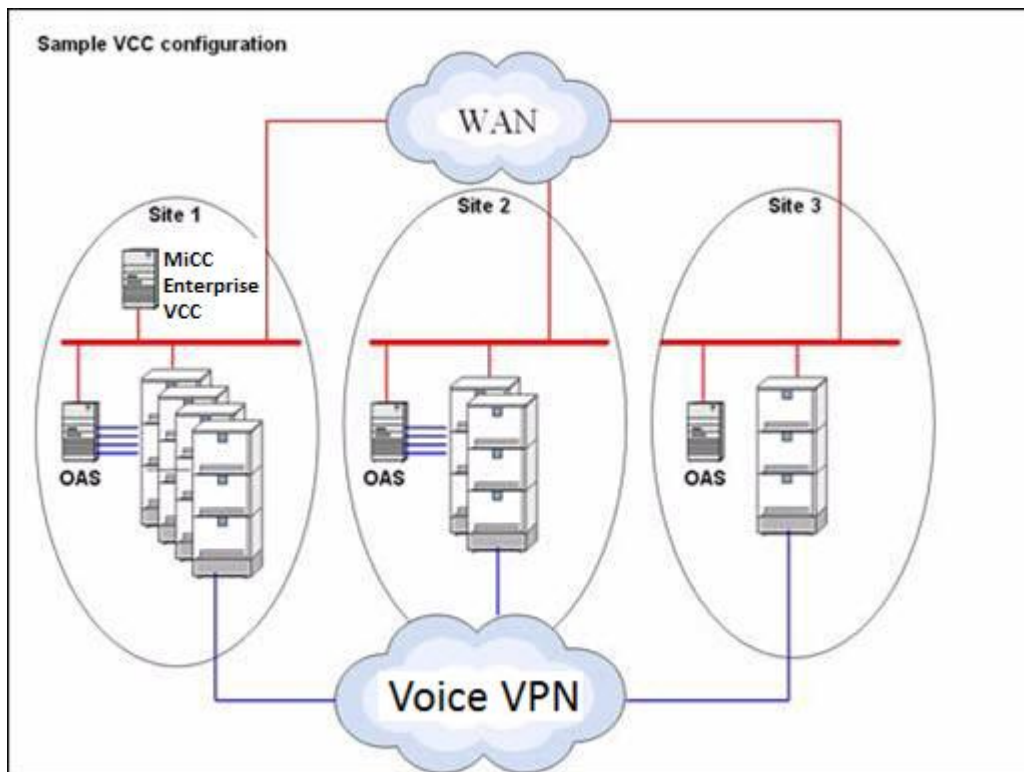



Figure 1: Sample VCC Configuration

In the sample above, there are three sites. The MiCC Enterprise server is located at Site 1. Each site has an OAS server. The OAS servers at Site 2 and 3 are connected to the MiCC Enterprise server at site 1 through a Wide Area Network (WAN). The three MX-ONE systems are connected in a Virtual Private Network (VPN) via ISDN tie-lines, IP Networking or SIP trunks

2.  Note: Each OAS server must have a unique node ID defined when multiple OAS servers are used with MiCC Enterprise. Each OAS Server node id in the entire virtual contact center, not just the site, must be unique. The node ID can be modified in the OAS configuration tool in the NRM section.

Configuration Manager can be used to configure site information. See Figure 2 below for the sample VCC configuration for the VCC shown in Figure 1 above.

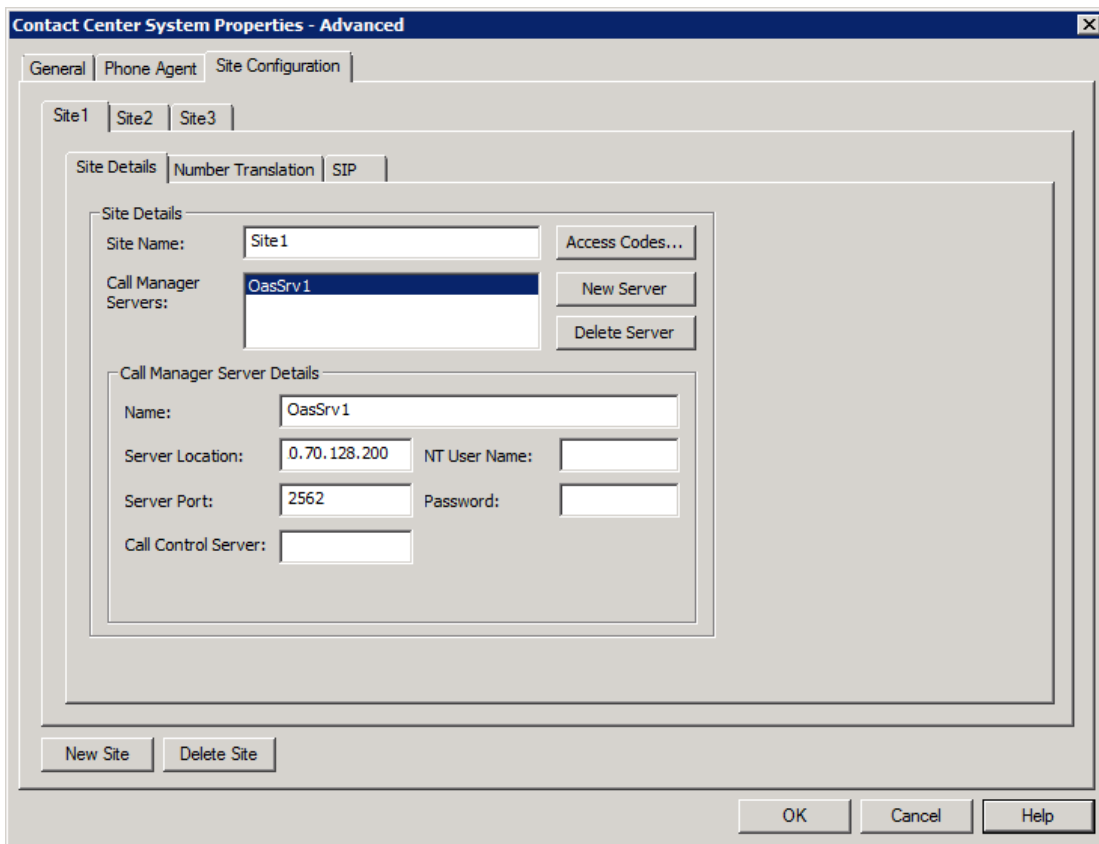

Figure 2: Screen shot of Site Configuration screen in CM

MULTIPLE OAS SERVERS

One site can be configured to use more than one OAS server, see Figure 3 below. Up to four OAS servers can be configured per site. This could be needed for capacity reasons or for redundancy. MiCC Enterprise can be configured to use up to 20 OAS servers.



Note: Each OAS server must have a unique node id defined when multiple OAS servers are used with MiCC Enterprise. Each OAS node id in the entire virtual contact center, not just the site, must be unique. The node id can be modified in the OAS configuration tool in the NRM section.

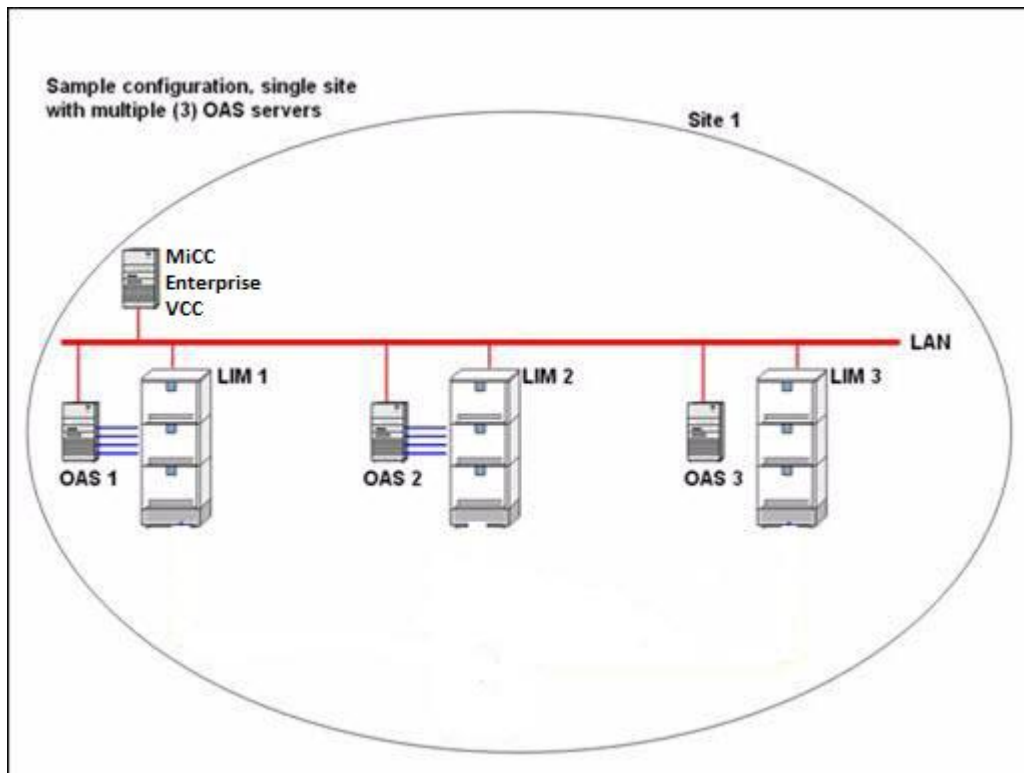

Figure 3: Multiple OAS Servers

See Figure 3 above for an example of configuration of a multiple OAS servers.

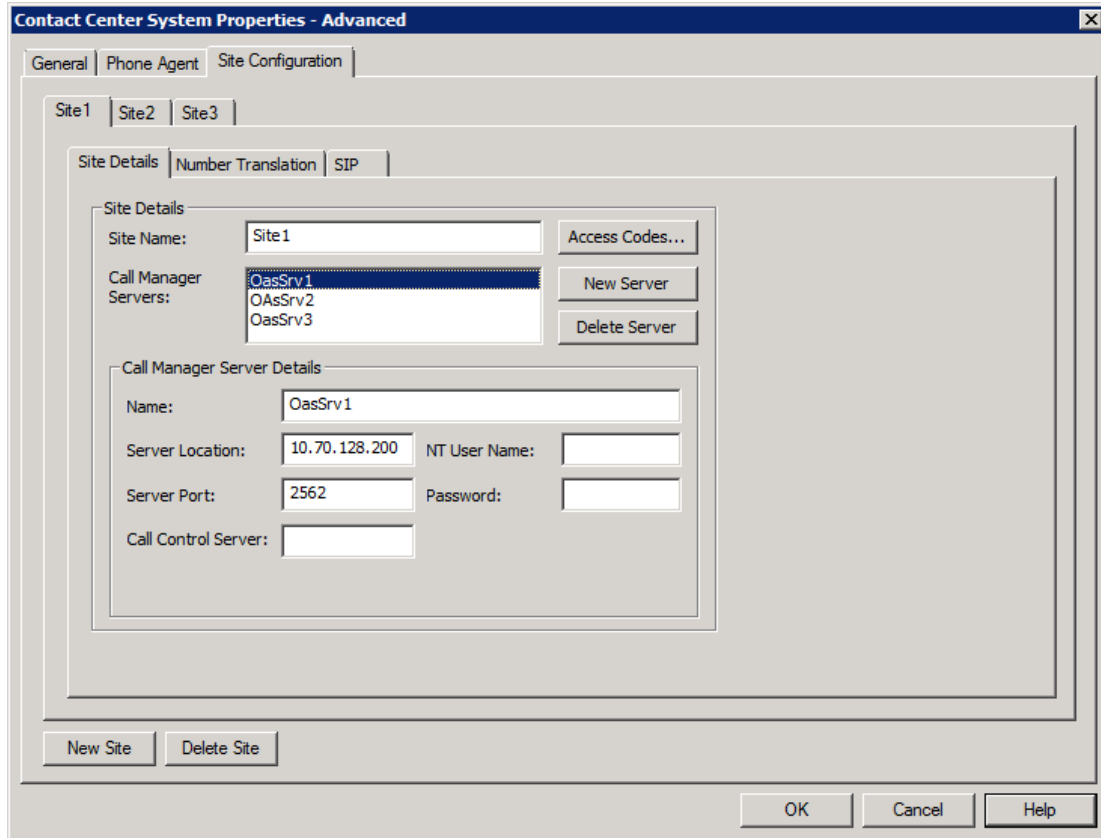

Figure 4: Site Details in Configuration Manager

NUMBERING PLANS

Since the MX-ONE call manager in a VCC network do not provide a network unique call identifier for calls between nodes, OAS servers and MiCC Enterprise are relying on that the correct number information is received from the MX-ONE in the CSTA events. To ensure this, great care has to be taken when configuring the private network. As a general rule, you have to make sure the calling number presented on the telephone display of the called party is the number that the called party can use to call back to the calling party, and vice versa.



Note: For more information on configuration of different numbering plans, refer to the MX-ONE documentation.

DIFFERENT NUMBERING PLANS

MiCC Enterprise VCC supports different types of numbering plans.

The simplest one to configure is a Closed Numbering Plan. Other names for this are Coordinated Numbering Plan or Fixed Length Numbering Scheme. A closed numbering plan is used in a private network where there is no conflict between the first 1, 2 or 3 digits in the directory number

series. Any extension in the network is reached by dialing the directory number of the extension, irrespective of in which site the calling party is situated.

Another type of numbering plan is Open Numbering Plan, also called Uniform Numbering Plan, Location Code Based Numbering Plan or Variable Length Numbering Scheme. An open numbering plan is where each location (site) in the private network needs a unique identifier, a location code, since different sites in the network can have extensions with identical directory numbers.

MiCC Enterprise also supports a mixture of these types, Mixed Numbering Plan. In these types of networks, some sites use a closed numbering plan for calling between these sites, and other sites need a location code to be reached.

CLOSED NUMBERING PLAN

In the example shown in Figure 5 below, extension 1000 in Site 1 is reached in the same way, by dialing 1000, from any site in the network. In Site 2 and 3, the Route access code 1 is assigned to the Route connected to site 1. This is done by MX-ONE Telephony switch commands NANSI and RODDI.

Example:

```
NANSI, NYMTYP=ED, NUMSE=1;  
RODDI : ROU=x, DEST=1, SRT=1, ADC=xxx;
```



Note: The Examples provided here are for MX-ONE TSW. For MX-ONE TSE some of the commands have different syntax, for instance command NANSI is replaced by command number_initiate.

No Access Code configuration is needed in the MiCC Enterprise Setup Utility for a VCC using Closed Numbering Plan.

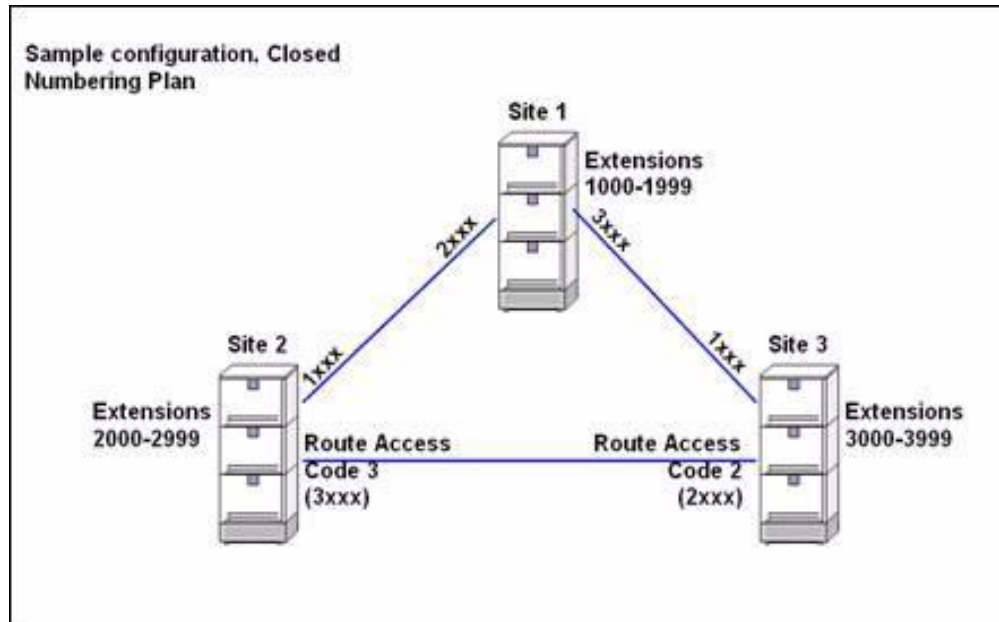

Figure 5: Closed numbering plan

OPEN NUMBERING PLAN

In the example in Figure 6 below, each Site in the network is reached by dialing a location code (access code). This access code is defined in each node as its Own Exchange Number. To reach extension 5000 in Site 2 from Site 1 you first dial access code 820 then the extension number 5000. In Site 1 you would configure:

```

NANSI : NUMTYP=EN, NUMSE=810 ;
NANSI : NUMTYP=ED, NUMSE=820&830 ;
NANLS : EXL=820&830, MIN=7, MAX=7 ;
RODDI : DEST=820, ROU=x, SRT=1 or 3, ADC=xxx6xxx... ;
RODDI : DEST=830, ROU=y, SRT=1 or 3, ADC=xxx6xxx... ;

```

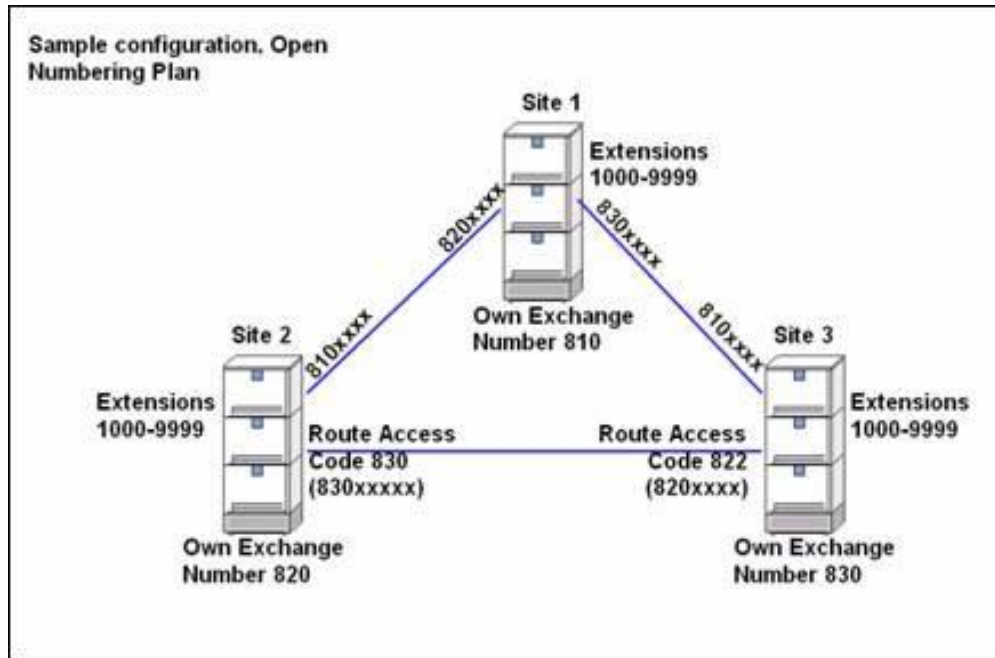

Figure 6: Open numbering plan

The ADC parameter should state the appropriate Type of Number (TON) for the calling private number. This is so that we can set the Exchange Number for Private Network correctly using the RONDI command:

```
RONDI:ROU=x,EXNOPR=6-810; RONDI:ROU=y,EXNOPR=6-810;
```

This would set the TON to Local Private, and prefix the calling number, 4000, with 810 so that the called extension 5000 would see 8104000 as the calling party.

These Access codes has to be configured in the MiCC Enterprise Setup Utility. For each site, the Access codes needed to reach the other sites from this site has to be entered. So for Site 1, the data in Figure 7: on page 10 and Figure 8 below has to be entered.

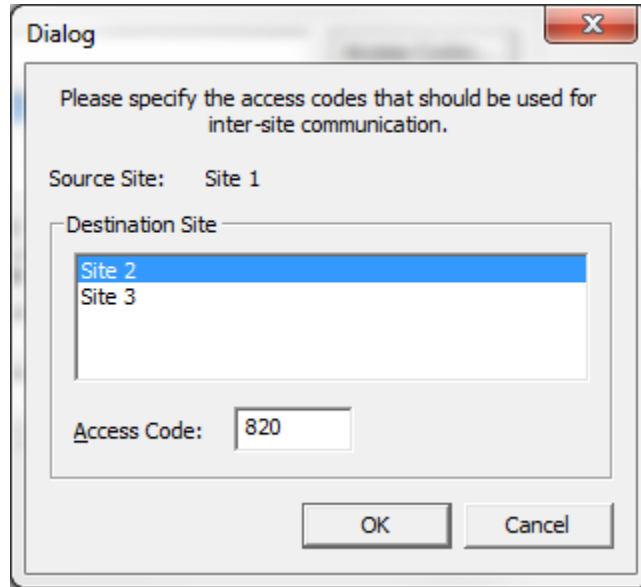

Figure 7: Data for Site 2

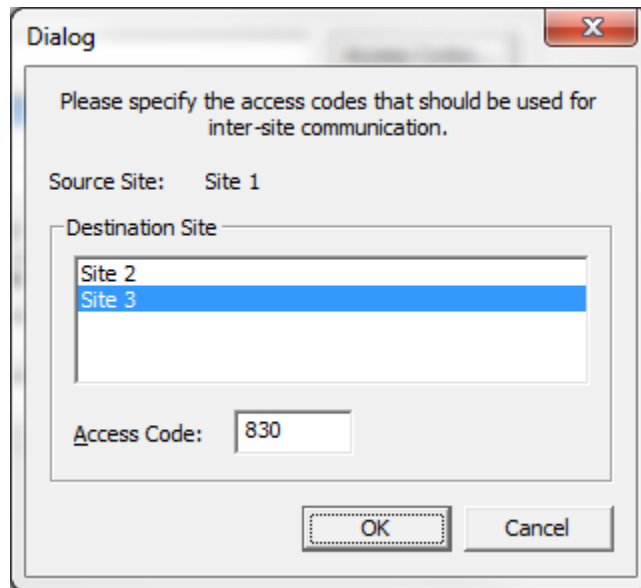

Figure 8: Data for Site 3

Sites 2 and 3 have to be configured in the same way.

MIXED NUMBERING PLAN

In the example in Figure 9: on page 11, when an extension in Site 1 or 2 wants to call an extension in Site 3 or 4 it would dial 850xxx. Calls from Site 3 and 4 to Site 1 and 2 would dial 800xxxx.

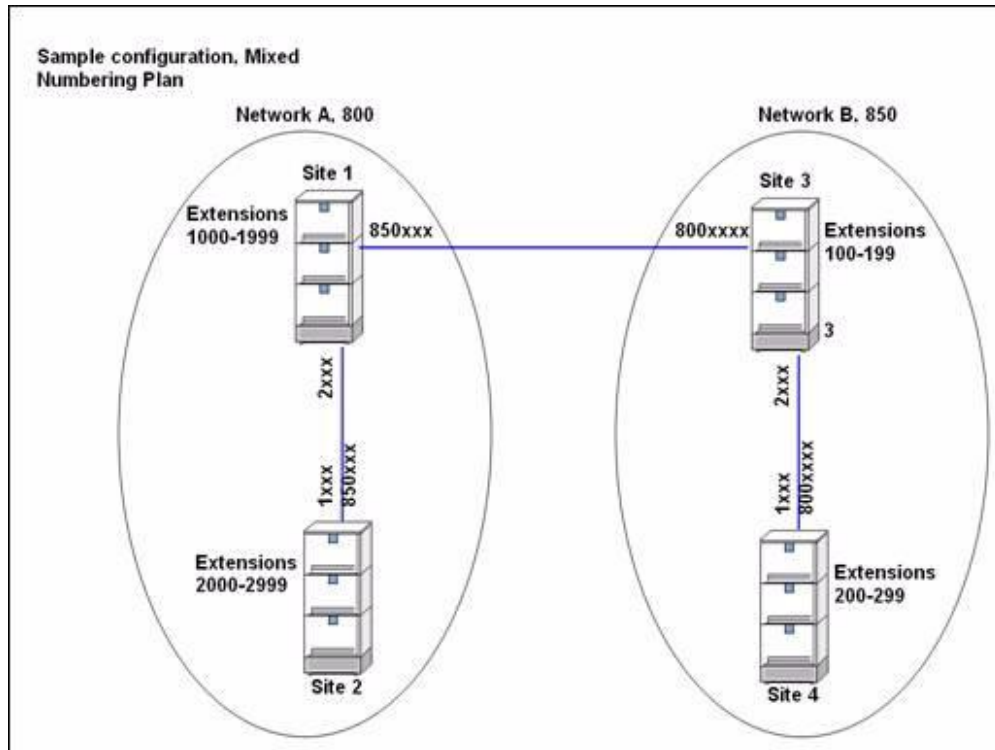

Figure 9: Mixed numbering plan

MX-ONE Telephony switch configuration for **Site 1**:

```
NANSI:NUMTYP=EN,NUMSE=800; NANSI:NUMTYP=EC,NUMSE=2;
NANSI:NUMTYP=ED,NUMSE=850; NANLS:EXL=2,MIN=4,MAX=4;
NANLS:EXL=850,MIN=6,MAX=6;
RODDI:ROU=x,DEST=2,SRT=1,ADC=x...;
RODDI:ROU=y,DEST=850,SRT=1 or 4,ADC=xxx6xxx...;
RONDI:ROU=y,EXNOPR=6-800;
```

MX-ONE Telephony switch configuration for **Site 2**:

```
NANSI:NUMTYP=EN,NUMSE=800; NANSI:NUMTYP=EC,NUMSE=1;
NANSI:NUMTYP=ED,NUMSE=850; NANLS:EXL=1,MIN=4,MAX=4;
NANLS:EXL=850,MIN=6,MAX=6;
RODDI:ROU=x,DEST=1,SRT=1,ADC=x...;
RODDI:ROU=y,DEST=850,SRT=1,ADC=xxx6xxx...;
RONDI:ROU=y,EXNOPR=6-800;
```

MX-ONE Telephony switch configuration for Site 3:

```
NANSI : NUMTYP=EN, NUMSE=850 ; NANSI : NUMTYP=EC, NUMSE=2 ;  
NANSI : NUMTYP=ED, NUMSE=800 ; NANLS : EXL=2, MIN=3, MAX=3 ;  
NANLS : EXL=800, MIN=7, MAX=7 ;  
RODDI : ROU=x, DEST=2, SRT=1, ADC=x... ;  
RODDI : ROU=y, DEST=800, SRT=1 or 4, ADC=xxx6xxx... ;  
RONDI : ROU=y, EXNOPR=6-850 ;
```

MX-ONE Telephony switch configuration for Site 4:

```
NANSI : NUMTYP=EN, NUMSE=850 ; NANSI : NUMTYP=EC, NUMSE=1 ;  
NANSI : NUMTYP=ED, NUMSE=800 ; NANLS : EXL=1, MIN=3, MAX=3 ;  
NANLS : EXL=800, MIN=7, MAX=7 ;  
RODDI : ROU=x, DEST=1, SRT=1, ADC=x... ;  
RODDI : ROU=y, DEST=800, SRT=1 or 4, ADC=xxx6xxx... ;  
RONDI : ROU=y, EXNOPR=6-850 ;
```

How the site information in Configuration Manager would look for Site 1 is presented in Figure 10 below.

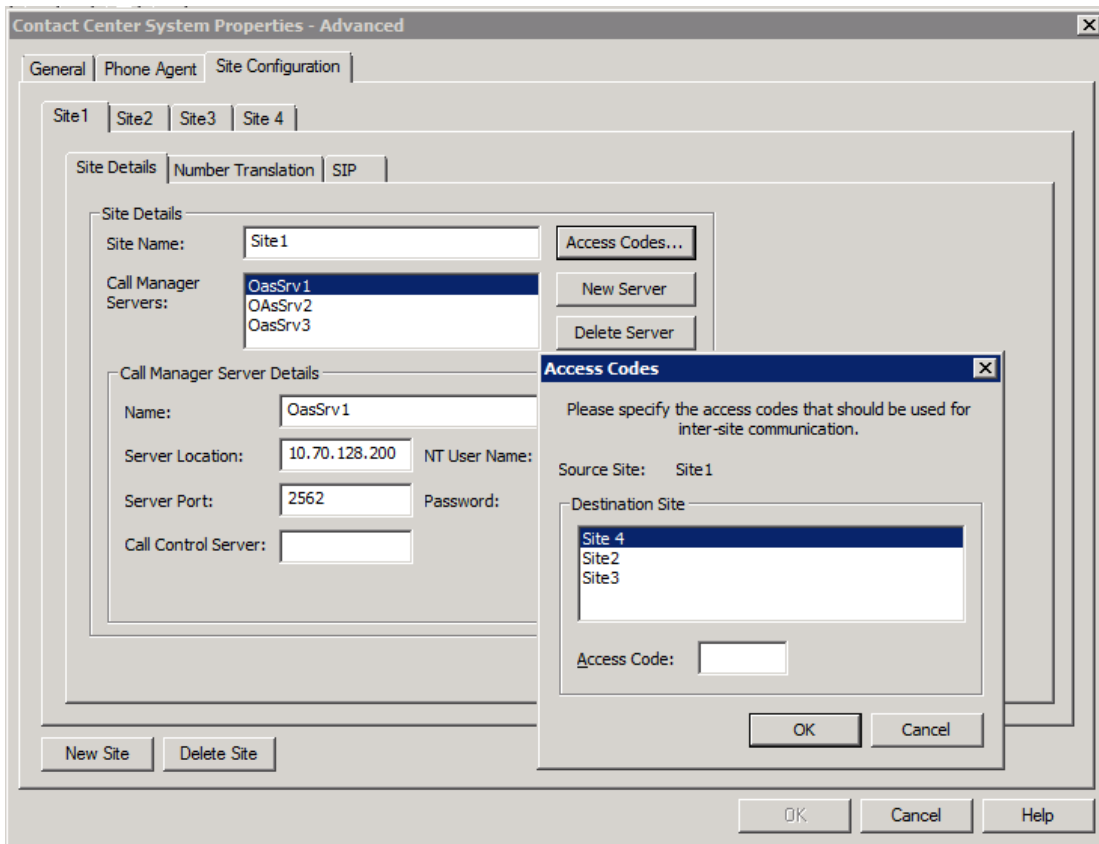

Figure 10:Site 1 in Configuration Manager

No Access Code needed for calls from Site 1 to Site 2. See Figure 11 and Figure 12 below for access codes for Site 3 and 4.

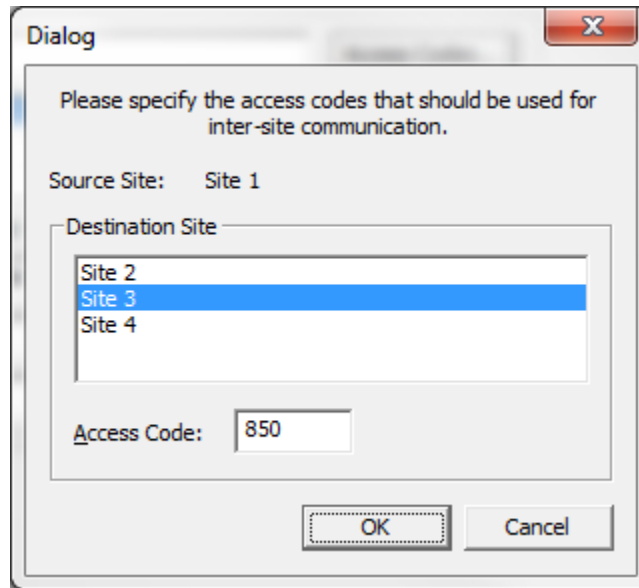

Figure 11: Site 3 as destination site

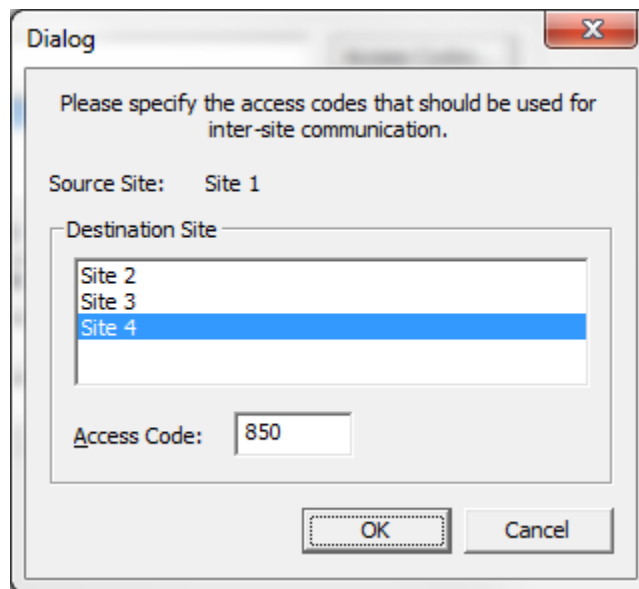

Figure 12: Site 4 as destination site

Access code 850 is needed for calls from Site 1 to Sites 3 and 4.

For Site 2, no Access code is needed for calls to Site 1. Access code 850 is needed for calls from Site 2 to Sites 3 and 4.

For Site 3, no Access code is needed for calls to Site 4. Access code 800 is needed for calls from Site 3 to Sites 1 and 2.

For Site 4, no Access code is needed for calls to Site 3. Access code 800 is needed for calls from Site 4 to Sites 1 and 2.

OAS CONFIGURATION

Each Site in the VCC network must be configured with at least one OAS server to provide call control services for the agents located at this site. An OAS system consists of three main components:

- Call Control Server (CCS)
- Media Server (MS)
- Network Resource Manager (NRM)

In order to provide local call control, OAS needs to be installed with NRM and CCS, see Figure 13 below for an overview.

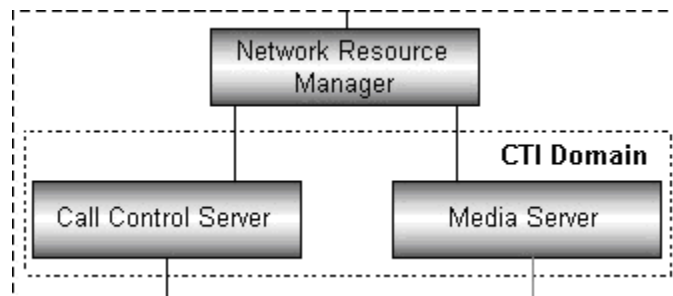

Figure 13: Overview of the connection between the three main components in an OAS system

How the OAS servers are configured for media services depend on a number of factors, such as:

- Where the calls enter the VCC and the location of the Service Access(es)
- Load balancing
- Redundancy
- Network utilization
- If Phone Agents will be used at the location or not

CENTRALIZED MEDIA RESOURCES

Consider the case where all calls enter the VCC at one location (site) and agents are located at this and two other sites. In this case, it could be beneficial to concentrate all media resources to the site where the calls enter the VCC. See Figure 14 below for a schematic overview.

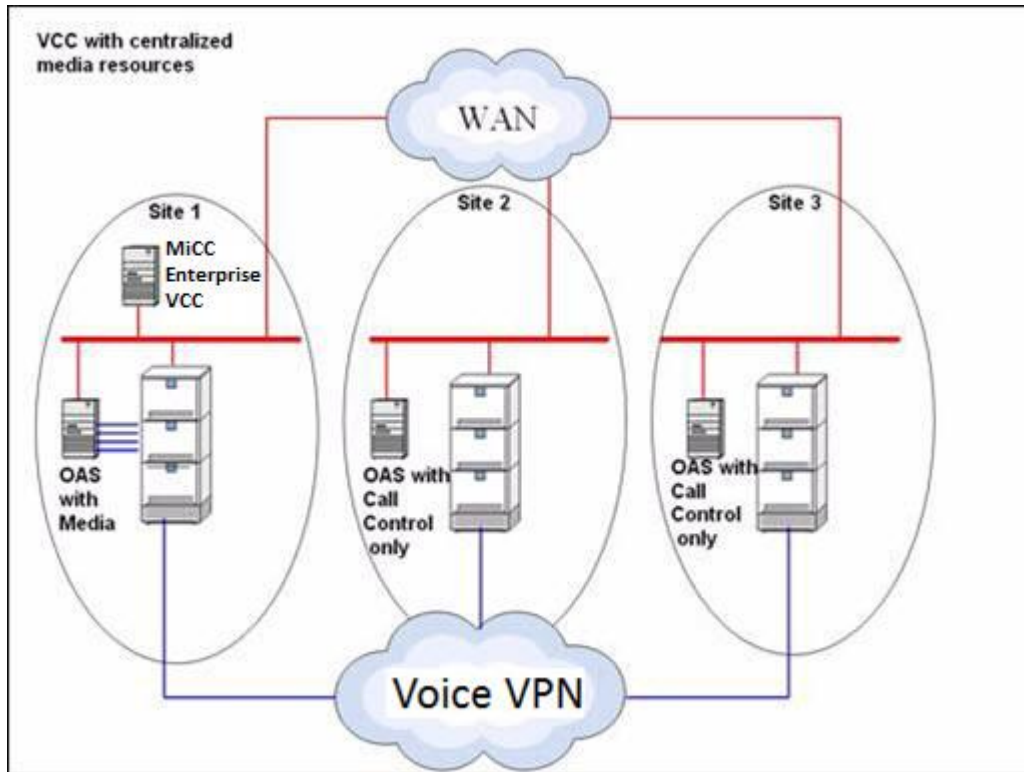

Figure 14: Overview of a Virtual Contact Center with centralized media resources

A second OAS with additional Media resources could be installed at Site1 for redundancy and load balancing purposes.



Note: If Phone Agents will be used, they would all have to be located in the site with the centralized media resources, or a few media channels have to be installed at all sites where Phone Agents will be present. This is because the script used by Phone Agents to logon and off, and to make them ready or not ready, needs media resources to play messages and to receive DTMF input.

Re-queue

In the scenario above, if an agent in Site 2 or 3 is presented with a call but does not answer, the call will be put back in a re-queue, and MiCC Enterprise will look for another agent to take the call. If you want the caller to be provided with repeated queue messages during this wait, then the re-queue device must be located in a Site with an OAS server with media services configured. It is recommended for this scenario that the re-queue device for the system is located in Site 1. By doing this, the call will be moved back to a CTI-group in the site where the call entered the network. No network resources will be occupied during the re-queue, and queue messages can be provided to the caller.

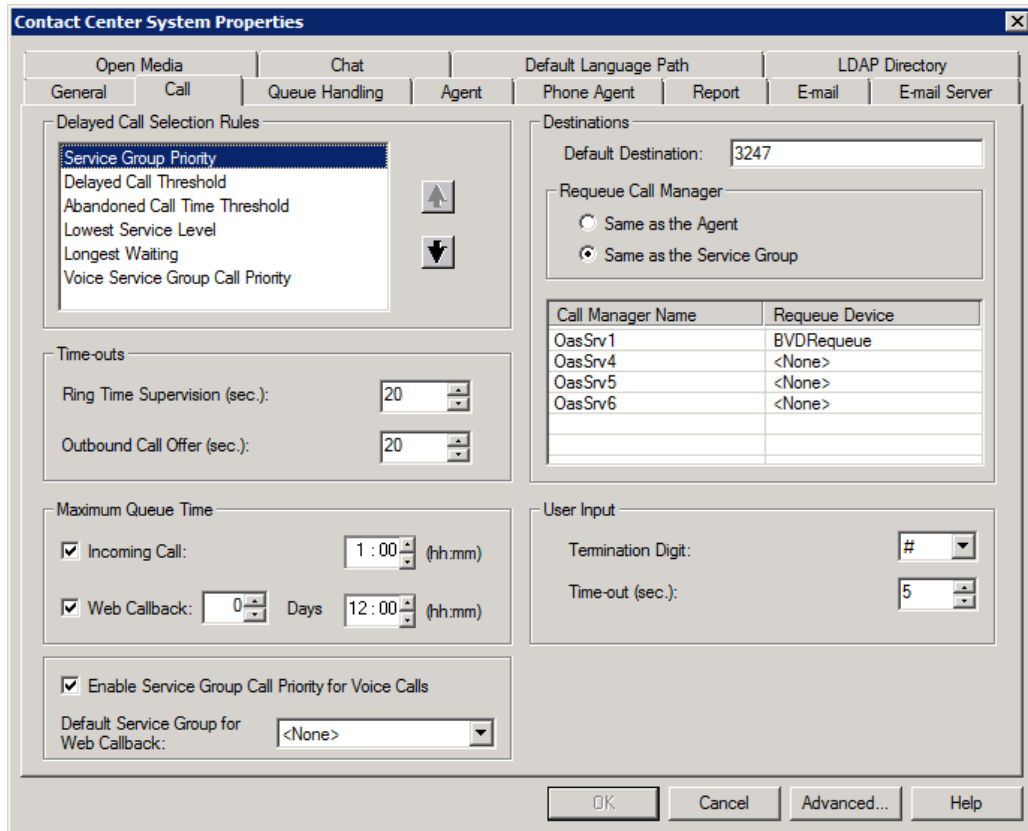

Figure 15: Contact Center System Properties

In the Contact Center System Properties, you should configure the MiCC Enterprise VCC system to use the Re-queue device defined for the OAS server of the Service group, see Figure 15 above.

Multiple media resources

Another scenario could be that calls enter the VCC at multiple locations in the network, see schematic overview in Figure 16 below, and in order to save private network resources, it could be more feasible to place the Service Access for the call in the Site where the call enters the network, and have media resources at multiple locations within the VCC.

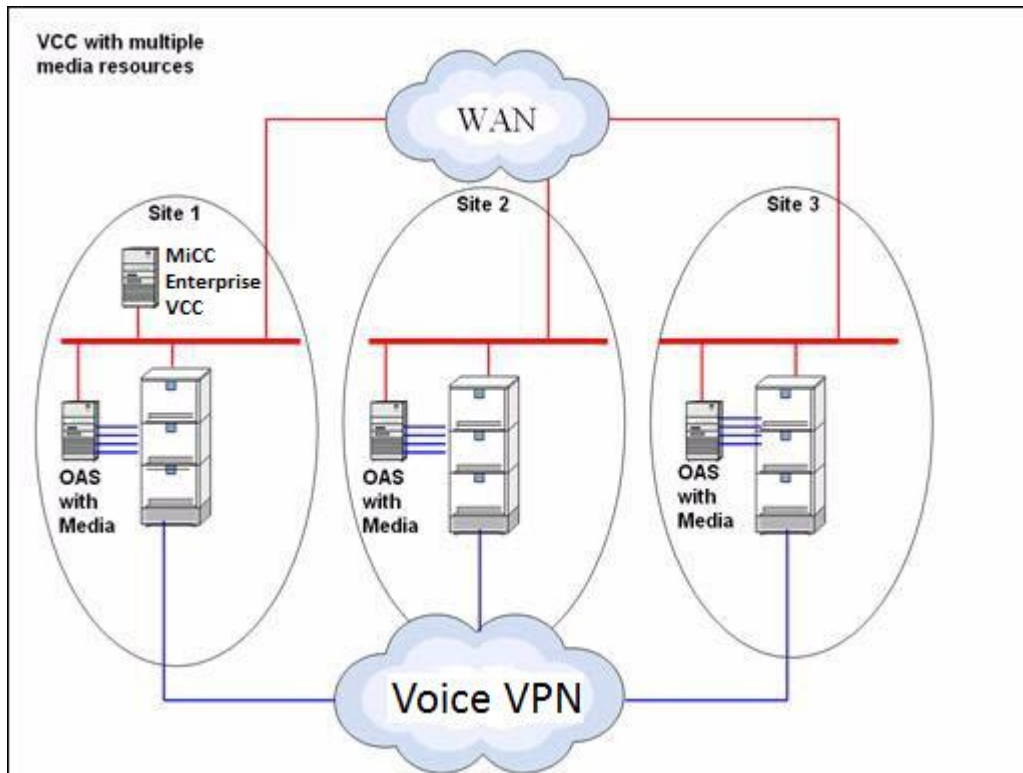

Figure 16: VCC with Multiple Media Resources

In the example above, all three sites have an OAS server with Media Services configured. One important consideration in these types of scenarios is that the OAS Media servers must be configured with the correct Play messages in order to achieve the wanted result. If calls entering a Service Access in Site 1 are handed over to, for example a Service Group called Sales, and also calls entering another Service Access in Site 3, is handed over to the same Service group (Sales), the Play messages for Queue messages and Repeat Queue messages must be configured in the same way in both the OAS servers. One way to guarantee this is to configure on one of the OAS servers and then copy the play.rep file to the other OAS server.

In the MiCC Enterprise system properties, you should configure the MiCC Enterprise VCC system to use the re-queue device defined for the OAS of the current Agent location, see Figure 15 above. This would eliminate sending the call back to the site where the call entered the VCC in case of re-queue.



mitel.com

© Copyright 2021, Mitel Networks Corporation. All Rights Reserved. The Mitel word and logo are trademarks of Mitel Networks Corporation, including itself and subsidiaries and authorized entities. Any reference to third party trademarks are for reference only and Mitel makes no representation of ownership of these marks.